



Integration der ORCID iD in das Identitätsmanagement der Universität Tübingen

82. DFN-Betriebstagung
Annalena Reuss, Universität Tübingen
25/03/2025



ORCID iD = persistenter Identifikator für die Wissenschaft

ORCID iD



iD

[https://orcid.org/
0000-0002-7631-7229](https://orcid.org/0000-0002-7631-7229)

Is this you? [Sign in to start editing](#)

Printable version

Name
Annalena Reuss

Activities

Collapse all

▼ Employment (1)

Sort

Eberhard Karls Universität Tübingen: Tübingen, DE

2022 to present | Personen- und Benutzermanagement (Zentrum für Datenverarbeitung)
Employment

[Show more detail](#)

Source: Annalena Reuss

▼ Works (1)

Sort

Borrelia burgdorferi modulates the physical forces and immunity signaling in endothelial cells

iScience
2022 | Journal article
DOI: [10.1016/j.isci.2022.104793](https://doi.org/10.1016/j.isci.2022.104793)
EID: 2-s2.0-85135954786

[Show more detail](#)

Part of ISSN: [25890042](#)
CONTRIBUTORS: Yuste, R.A.; Muenkel, M.; Axarlis, K.; Gómez Benito, M.J.; Reuss, A.; Blacker, G.; Tal, M.C.; Kraicz, P.; Bastounis, E.E.

Source: Annalena Reuss *via* Scopus - Elsevier ★ Preferred source (of 2)

ORCID Record



Ausgangssituation

- ORCID iD nicht ins Identitätsmanagement (IDM) eingebunden
- für jeden einzelnen Dienst muss die ORCID iD verknüpft werden



Ziele des Projekts

- zentrale Verknüpfung der ORCID iD mit dem universitären Benutzerkonto
- Weiterleitung der ORCID iD an nachstehende Dienste
- eröffnet die Möglichkeit, auch nach Verlassen der Uni, Zugriff auf seine Daten zu erhalten

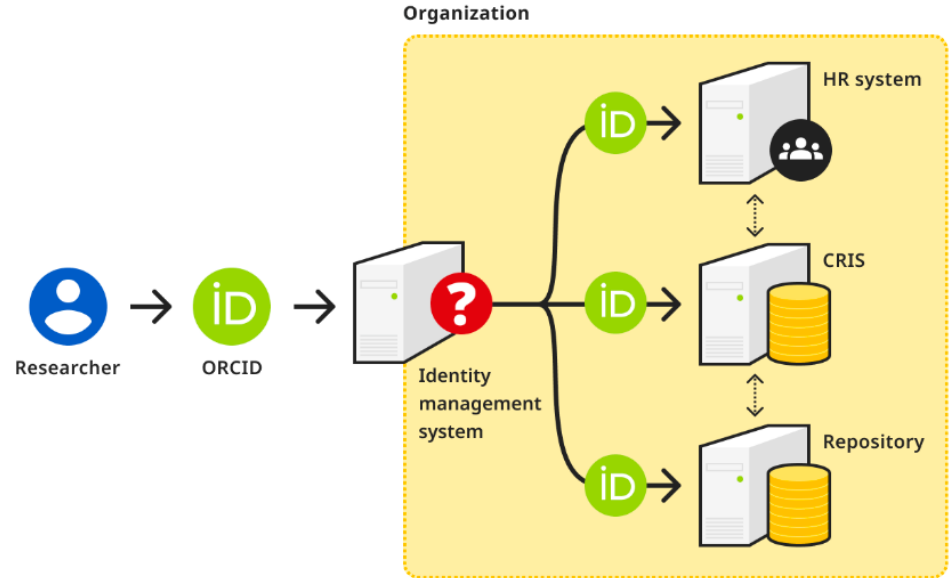

<https://info.orcid.org/documentation/workflows/sharing-user-permissions/>



Ziele des Projekts

- zentrale Verknüpfung der ORCID iD mit dem universitären Benutzerkonto
- Weiterleitung der ORCID iD an nachstehende Dienste
- eröffnet die Möglichkeit, auch nach Verlassen der Uni, Zugriff auf seine Daten zu erhalten

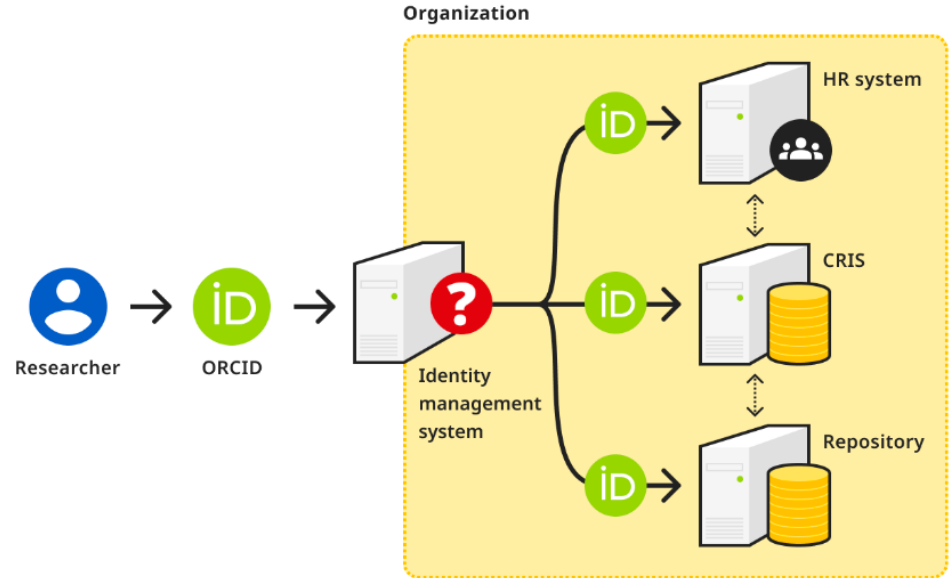

<https://info.orcid.org/documentation/workflows/sharing-user-permissions/>



Entwicklung einer Web-App

LinkID



Link your ORCID iD with University of Tübingen!

With LinkID you can link your ORCID iD to your user account at the University of Tübingen.

This way, your ORCID iD can be passed on to associated services of the University without the need for you to repeat the ORCID authentication process for each application.

Manage your linked ORCID iD

Before you start:

Make sure that you only have **one** ORCID iD. This is the only way to ensure that your research achievements are uniquely attributed to you.

If you do not have an ORCID iD yet, you can create one free of charge at www.orcid.org.

To check if you have already linked an ORCID iD to your user account at the university, go to [Manage your ORCID iD](#)

Connect ORCID iD:

1. Click on the tab "Manage your ORCID iD". You will now be asked to sign in with your university user account.
2. If you do not have a linked ORCID iD yet, please read the information on connecting the ORCID iD and confirm it by clicking on the button "Connect or create ORCID iD".
3. You will now be redirected to www.orcid.org, where you can log in with your ORCID iD or create an ORCID iD.
4. After the login at www.orcid.org you will be redirected back to the LinkID page where you will be informed about the successful connection.

Revoke Access:

If you have linked an ORCID iD, you can delete this connection at any time by selecting the ORCID iD you wish to disconnect and clicking the "Revoke Access" button.

You can find more information about ORCID iDs at www.orcid.org.

For further questions, please have a look at our [FAQ](#).



LOGIN @ UNI-TUEBINGEN

Shibboleth · Identity Provider

Dies ist die zentrale Anmeldeseite für das Single Sign-On der Universität Tübingen.

The service LinkID has requested that you log in using your personal user account at the University of Tübingen.

Username

[› Forgot your password?](#)

[› Need Help?](#)

Password

[› Terms of use](#)

Don't Remember Login

Clear prior granting of permission for release of your information to this service.

Login



About LinkID FAQ

Manage your ORCID iD

Link your ORCID iD!

1. Confirm the terms of use by clicking on the button "Create or connect ORCID iD".
2. You will be redirected to www.orcid.org, where you can log in with your ORCID iD or create an ORCID iD.
3. After the login at www.orcid.org you will be redirected back to the LinkID page where you will be informed about the successful connection.

By clicking "Create or connect your ORCID iD" you allow University of Tübingen to:

- store your ORCID iD
- read information on your ORCID record that is marked for trusted parties
- add/update your ORCID record

 [Create or connect your ORCID iD](#)



Sign in to ORCID

Don't have your ORCID ID yet? [Register now](#)

Email or ORCID iD

For example: joe@institution.edu or 0000-1234-5678-9101

Password

Sign in to ORCID

[Forgot your password or ORCID ID?](#)

OR



Sign in through your institution



Sign in with Google



Authorize access

You are currently signed in as:



Annalena Reuss

<https://orcid.org/0000-0002-7631-7229>

[Sign out](#)

University of Tuebingen

[Show details](#)

This organization has asked for the following access to your ORCID record:

- Add/update your research activities (works, affiliations, etc.)
- Get your ORCID iD
- Read your information with visibility set to Trusted parties

If authorized, this organization will have access to your ORCID record, as outlined above and described in further detail in [ORCID's privacy policy](#).

You can manage access permissions for this and other Trusted Organizations from within your list of [trusted parties](#).

Authorize access



[Deny access](#)



About LinkID FAQ

Manage your ORCID iD

Manage your ORCID iD

ORCID iD	ORCID record status	Info	Select
 https://orcid.org/0000-0002-7631-7229		This record is active on orcid.org	<input checked="" type="checkbox"/>

 Active  Merged  Deleted  Not available

To remove your ORCID iD from our systems and to revoke access to your ORCID record for the University of Tübingen, please select the corresponding ORCID iD and click on "Revoke Access".

Revoke Access



Workflow

LinkID

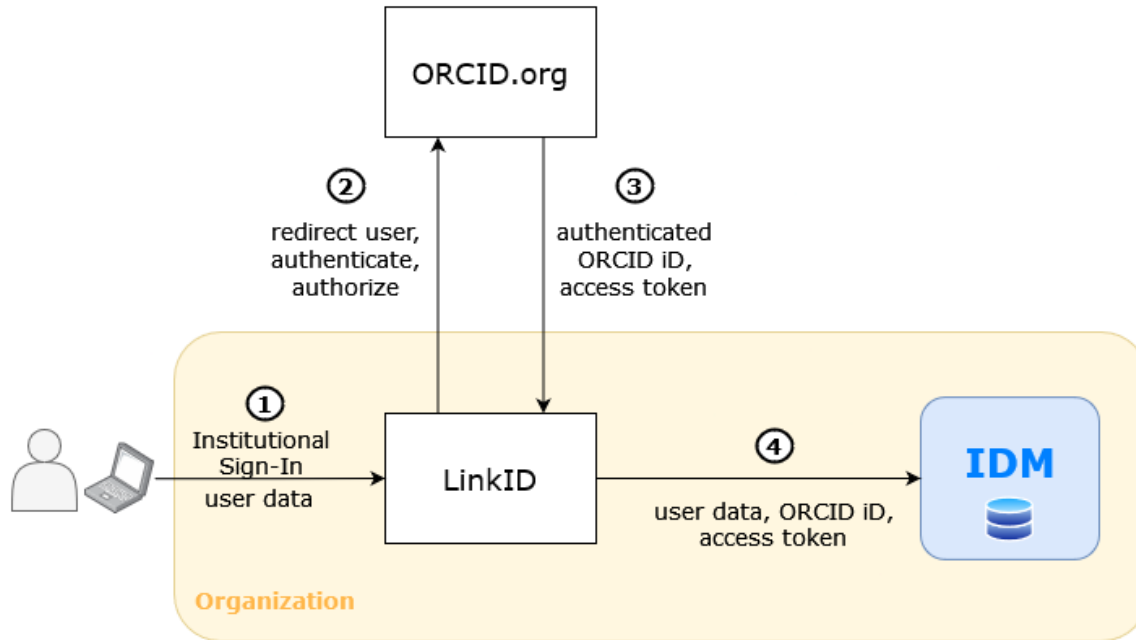

DB Schema

Zwei Tabellen:

- **User Data**











Uid 	Interne Id	Pairwiseld	FailedAttrQueries	ExpiresOn
---	------------	------------	-------------------	-----------



- **Orcid Data**

Orcid 	Interne Id	Access Token	Refresh Token	AccessStartDate	AccessEndDate	Record Status	Merged Into	Scope
---	------------	--------------	---------------	-----------------	---------------	---------------	-------------	-------

Deprovisionierung

- Gelöschte oder zusammengelegte ORCID Records können erkannt und durch den Nutzer selbst verwaltet werden
- Inaktive Nutzer können über eine Attribute Query erkannt und aus den universitären Systemen entfernt werden

ORCID iD	ORCID Record Status	Info	Select
 https://sandbox.orcid.org/0000-0000-0000-0000		This record does not exist and can be deleted.	<input checked="" type="checkbox"/>
 https://sandbox.orcid.org/0000-0003-17-████████		This record is active on orcid.org	<input type="checkbox"/>
 https://sandbox.orcid.org/0000-0003-18-████████		This record is active on orcid.org	<input type="checkbox"/>
 https://sandbox.orcid.org/0009-0000-20-████████		This record was deactivated on orcid.org and can be deleted.	<input checked="" type="checkbox"/>
 https://sandbox.orcid.org/0009-0009-41-████████		This record has been merged into the following ORCID iD that you have already connected: https://sandbox.orcid.org/0000-0003-████████ You can safely delete the ORCID iD marked as merged.	<input type="checkbox"/>

 Active  Merged  Deleted



Limitationen

“The ORCID iD and the access tokens can then be securely transferred to any other system that your organisation needs to capture ORCID iDs such as your CRIS system, HR or an institutional repository. ”

<https://info.orcid.org/documentation/workflows/sharing-user-permissions/>

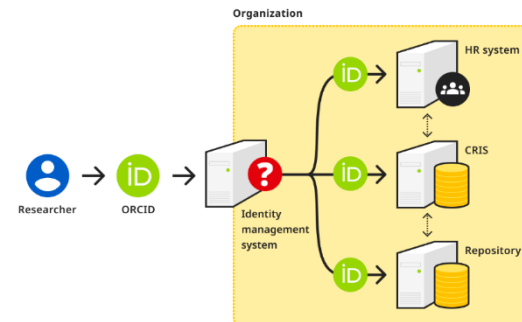



Limitationen

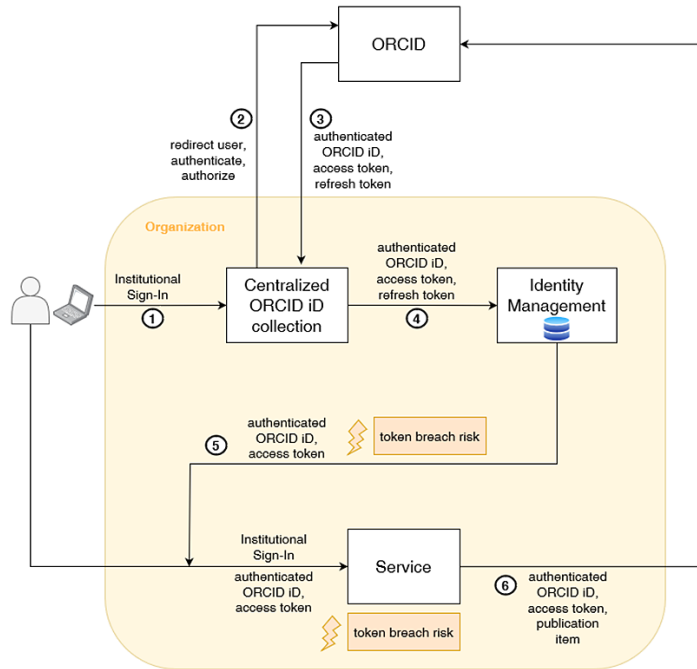

Information to be Provided to Service

First name(s)	[REDACTED]
Mailbox Address	[REDACTED]
Orcid	https://sandbox.orcid.org
Pseudonymous service-specific id	[REDACTED]
Surname	[REDACTED]
Orcid Access Token	ec6c2798- [REDACTED]
Data	2043-09-21 /read-limited openid /activities/update



Limitationen

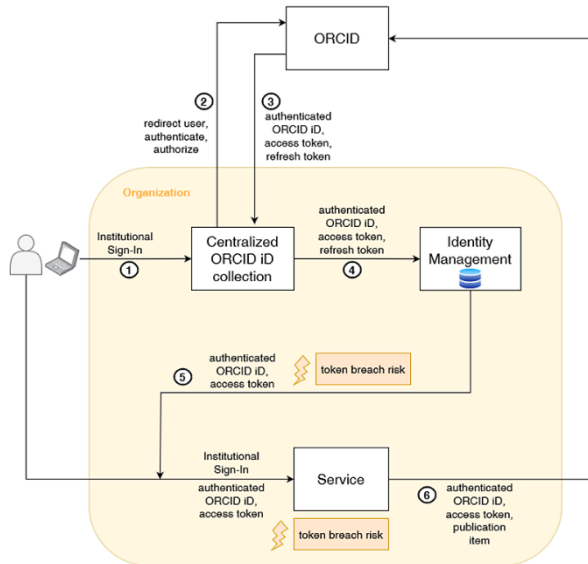

Information to be Provided to Service	
First name(s)	[REDACTED]
Mailbox Address	[REDACTED]
Orcid	https://sandbox.orcid.org [REDACTED]
Pseudonymous service-specific id	[REDACTED]
Surname	[REDACTED]
Orcid Access Token	ec6c2798-[REDACTED]
Data	2043-09-21 /read-limited openid /activities/update

- Token wird dem Nutzer angezeigt und kann missbraucht werden



Limitationen

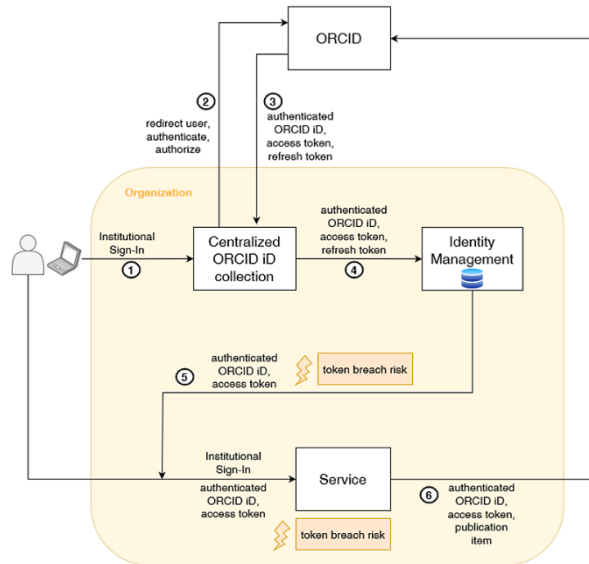

Information to be Provided to Service	
First name(s)	[REDACTED]
Mailbox Address	[REDACTED]
Orcid	https://sandbox.orcid.org [REDACTED]
Pseudonymous service-specific id	[REDACTED]
Surname	[REDACTED]
Orcid Access Token	ec6c2798-[REDACTED]
Data	2043-09-21 /read-limited openid /activities/update

- Token wird dem Nutzer angezeigt und kann missbraucht werden
- Jeder Dienst, dem das Token weitergegeben wird, ist ein potenzielles Risiko



Limitationen

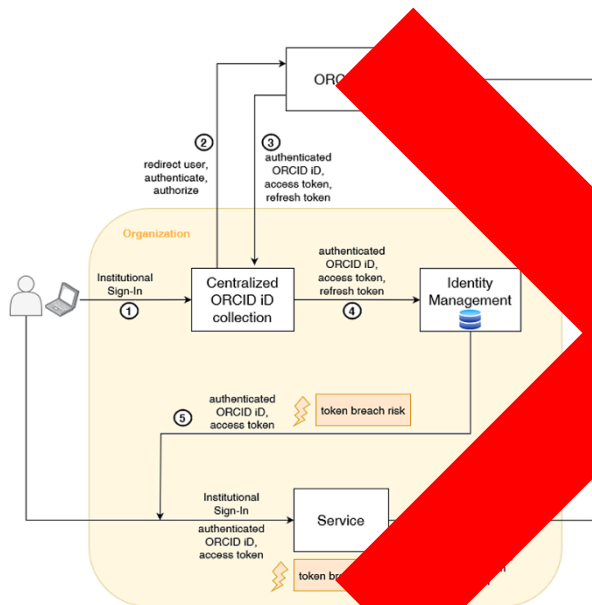

Information provided to Service	
First name(s)	[REDACTED]
Mailbox Address	[REDACTED]
Orcid iD	https://sandbox.orcid.org [REDACTED]
Specific id	[REDACTED]
Access Token	ec6c2798-[REDACTED] 2043-09-21 /read-limited openid /activities/update

- Token wird dem Nutzer angezeigt und kann missbraucht werden
- Jeder Dienst, dem das Token weitergegeben wird, ist ein potenzielles Risiko

Lösungsansatz: Proxy

- Dazwischenschalten eines Proxy Dienstes (REST-API), der mit dem ORCID Record interagiert

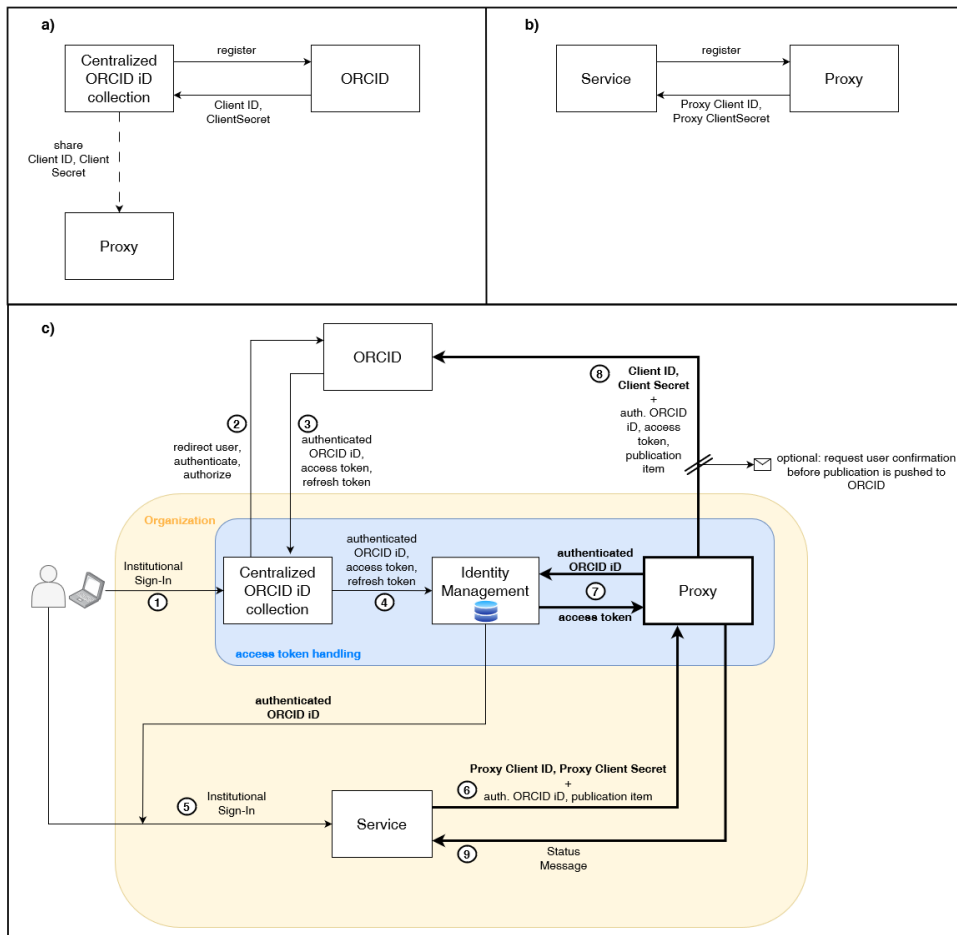



Proxy - Workflow

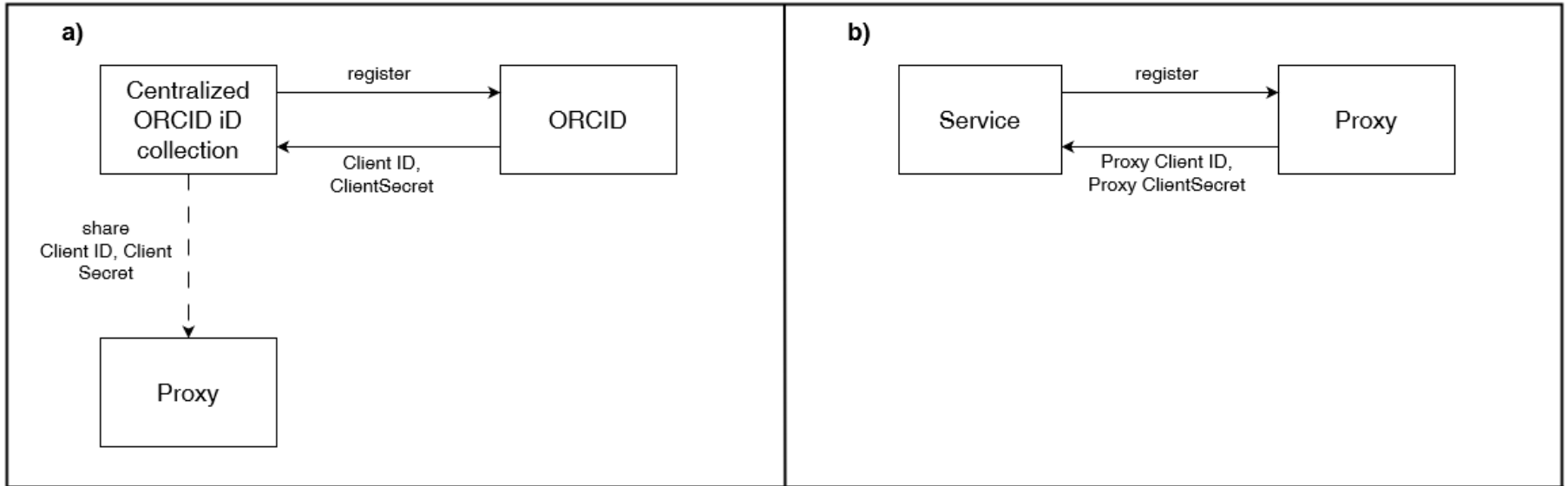



Proxy - Workflow

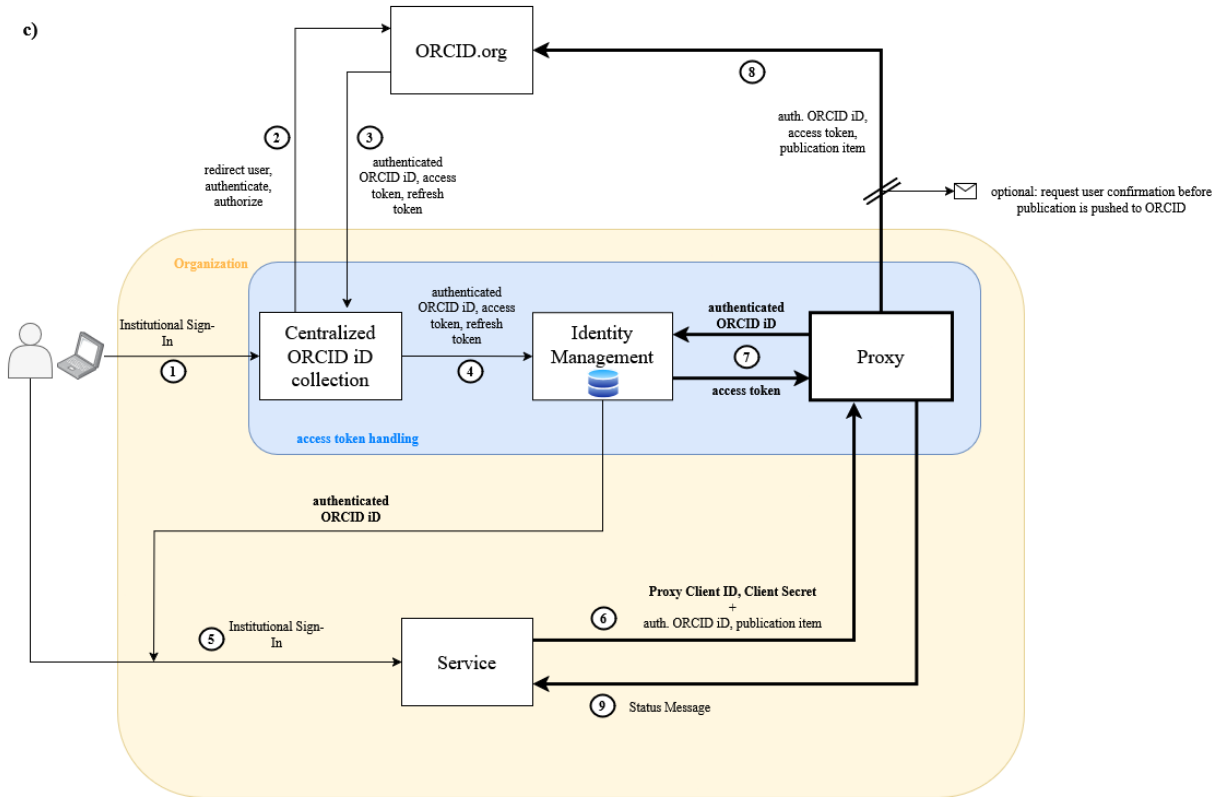



Fazit

- ORCID iD kann über LinkID einfach mit bestehenden Nutzerkonten verknüpft werden
 - Organisationen, die ORCID Berechtigungen mit weiteren Diensten teilen wollen, sollten die Implementierung eines Proxy Dienstes in Erwägung ziehen, der die Interaktion mit ORCID Records übernimmt
- Token Breaches verhindern

Zusätzliche Infos

2023 Third International Conference on Digital Data Processing (DDP)

Trust issues: Why we should handle ORCID trust markers with care and how we can improve their trustworthiness through more secure workflows in ORCID integrations

^{1st} Annalena Reuss
Zentrum für Datenverarbeitung
Eberhard Karls Universität Tübingen
Tübingen, Germany
<https://orcid.org/0000-0002-7631-7229>

^{2nd} Axel Braun
Universitätsbibliothek
Eberhard Karls Universität Tübingen
Tübingen, Germany
<https://orcid.org/0000-0003-2879-2970>

^{3rd} Ramon Pfeiffer
Zentrum für Datenverarbeitung
Eberhard Karls Universität Tübingen
Tübingen, Germany
<https://orcid.org/0000-0002-4059-7038>

Abstract—Initially developed to facilitate author identification, ORCID (Open Researcher & Contributor ID) provides persistent identifiers (ORCID IDs) to researchers and since has become an elementary part in research and academic publishing. Being a community-driven effort, that allows user generated content, one of ORCID's core values is trust. This is also reflected in the trust markers, which are placed on every entry in an ORCID record to assert its data provenance. Trust markers are usually organizations, that an ORCID record holder has authorized to update their record and act as a trusted party. During the authorization process, an access token which is required to update the ORCID record, is issued to the trusted party. This paper examines the trustworthiness of trust markers: on the one hand, access permissions and tokens can be shared between multiple services, on the other hand, token breaches are a well-known threat. Breached access tokens allow to modify an ORCID record in the name of a trusted party, thus invalidating the credibility of trust markers. We propose a secure approach for institutions wanting to share access permissions with multiple services. This will enhance the trustworthiness of ORCID's trust markers and increase their value to researchers and organizations.

of trust include fake ORCID records [5], over-identified users (i.e., multiple ORCID records for one individual), overloaded ORCID records (i.e., records held by organizations listing publications of all their affiliated authors) [6] and even academic fraud (i.e., researchers claiming credit for work of others) [7]. To address these threats ORCID already has measures in place, e.g., the completion of a CAPTCHA is required for the creation of an ORCID record to minimise the registration of fake accounts by bots and heuristics are applied to detect spam accounts. ORCID records that claim credit for other researchers' work or contain deceptive information in an attempt of academic fraud are much more difficult to monitor [7]. Therefore, ORCID clearly forbids this in their terms of use [8] and encourages the community to report any concerning claims [7].

To assert the data provenance of ORCID record entries, ORCID places so called "trust markers" on each item of an ORCID record, which are displayed as the "source" of the

<https://ieeexplore.ieee.org/abstract/document/10418834>